



APPLICATIONS SUBMITTED TO  
THE VALUE AND QUALITY TENDER  
IN 2024



# VALUE AND QUALITY AWARD TENDER 2024

Applicant:

**Balázs-Diák Kft.**

Headquarters: 1138 Budapest, Szekszárdi utca 12/a

Mailing address: 1138 Budapest, Szekszárdi utca 12/a

Phone: +3612665140

e-mail: virag@taneszkoz.hu

web: www.balazs-diak.hu

Application:

**StarSchool**

## StarSchool pedagogical framework, online space for adaptive learning using AI

The Star School, an adaptive learning support system using AI, is a digital, modular system that primarily develops skills and allows preschool and school children to practise the curriculum. Nearly 15,000 modules make up the elements of the game software that form the basis of the pedagogical framework available online. They have been categorised according to their characteristics, labelled according to which sub-skills they can be used to develop, which curriculum they can be used to practice and for which age group they are recommended. These modules can be combined according to the teacher's or parent's wishes, or the algorithm can generate game paths automatically after learning about the children.

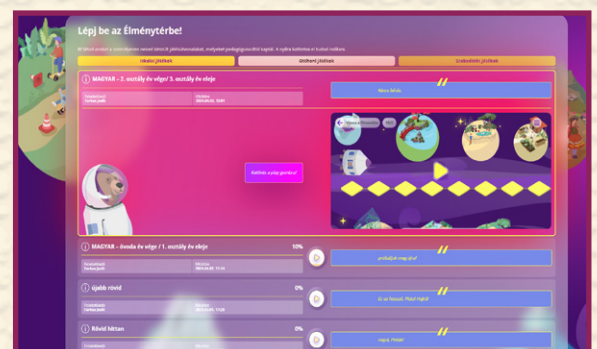
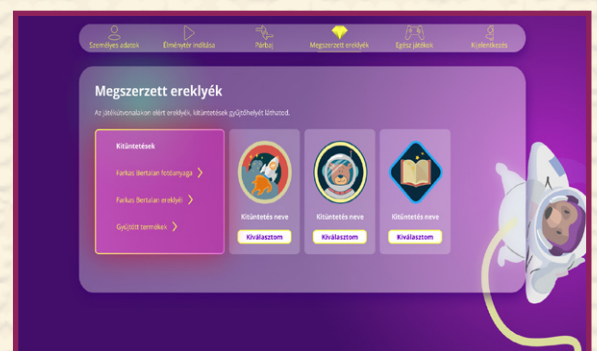





Applicant:

## **Bastion Guard Kft.**

Headquarters: 1036 Budapest, Bécsi út 81.

Mailing address: 1036 Budapest, Bécsi út 81.

Phone: +36209208393

e-mail: [info@bastion.hu](mailto:info@bastion.hu)

web: [www.bastion.hu](http://www.bastion.hu)

Application:

### **Humanoid robot with artificial intelligence**

Bastion Guard has been at the forefront of business protection for over two decades, continuously responding to the changing market demands. Addressing the heightened security needs brought on by the COVID-19 crisis, the company ensures flawless security through innovative solutions such as robotics, drones and e-long based systems.

The services of the company combine high-quality traditional guarding with modern, proactive technologies, guaranteeing the clients' safety and peace of mind. Their founders have been active sector for over 2 years, offering premium services ranging from security assessments to development plans. Every activity of Bastion Group is focused on ensuring maximum client security, allowing the partners to concentrate on their business goals with the confidence that their safety is in good hands.







Applicant:

**Ceralbin Kft.**

Headquarters: 1065 Budapest, Lázár utca 14. földszint

Mailing address: 1065 Budapest, Lázár utca 14. földszint

Phone: +36304152413

email: argaymarton@szentrokuspatika.hu

web: www.ceralbin.hu

Application:

## Ceralbin cosmetic product line

Regenerating hand cream for dry skin, Nourishing ointment, Moisturising body lotion, Chamomile-vanilla lip balm, Oil bath, Omega Fatty Acid body cream, Bath cream

The skin is the first line of defence against the environment, and when its hydration is compromised, i.e. the lipid layer of the skin is reduced, the skin becomes dry. Dry skin is more vulnerable to irritation, and it is not uncommon for it to become inflamed or even attacked by bacterial or fungal infections. Therefore, extra attention should be paid to the treatment of dry skin. This is where the Ceralbin range comes in. The primary goal in formulating the formula was to focus on skin-friendly ingredients of natural origin, as nature is full of valuable substances that are beneficial to the skin. Thanks to their expertise as pharmacists, they have managed to combine these ingredients in a unique way, resulting in products that can be recommended to several generations of the family, even for everyday use, for the pleasure of our skin and ourselves.



VALUE AND QUALITY AWARD TENDER 2024





Applicant:

## Ceres Sütőipari Zrt.

Headquarters: 9027 Győr, Reptéri utca 1.

Mailing address: 9027 Győr, Reptéri utca 1.

Phone: +3696513500

e-mail: [ceres@ceressuto.hu](mailto:ceres@ceressuto.hu)

web: [www.ceressuto.hu](http://www.ceressuto.hu)

Application:

## Ceres Napicipó (daily loaf) product range

Napicipó with wheat flour - wheat bread 400g; Napicipó Wholemeal - wholemeal bread 400g; Napicipó Whole grain spelled - whole grain spelled bread 350g  
Napicipó with seeds - with flax, sunflower, pumpkin and sesame seeds 400g

The Napicipó product range offers a wide choice from the most popular light breads to breads for health-conscious consumers. Napicipó bread with wheat flour - a bread made from pure 72% wheat flour, carefully baked, with a soft texture.

Whole-wheat breads have a higher dietary fibre content, and wholemeal wheat flour contains the cleaned husk of wheat, bran.

Day loaf whole grain spelled – this sliced loaf of bread is made from spelled flours with a more favourable physiological effect, with minimal use of other grain mills, which can contribute to a balanced diet.

Sunflower seeds-bread made with 5% seeds (using flax seeds, sunflower seeds, pumpkin seeds and sesame seeds) also contains 13% graham flour and rye flour.



VALUE AND QUALITY AWARD TENDER 2024





Applicant:

## CSOMIÉP Beton és Meliorációs Termékgyártó Kft.

Headquarters: 6800 Hódmezővásárhely, Makói út CSOMIÉP Ipartelep

Mailing address: 6800 Hódmezővásárhely, Pf.: 117.

Phone: +3662535730

e-mail: beton@csomiep.hu

web: www.csomiep.com

Application:

### Light Railway Level Crossing System, level crossing panel, stepped transition panel

The light railway level crossing system is by and large the same as the level crossing system made of large precast rail-channel panels with synthetic macro-fibre reinforcement, patented by CSOMIÉP Kft. for standard railways, but it has been adapted for narrow-gauge light railways. The primary function of the level crossing system made of large precast rail-channel panels with synthetic macro-fibre reinforcement is to allow that both railway traffic and road traffic can cross intersections at the same level with safety, without decreasing their speed. The main elements of the system are the modular prefabricated level crossing panels and stepped transition panels made of concrete with synthetic fibre reinforcement. The rail channels formed in the panels ensure safe and flexible fastening of the rails by means. The level crossing panels provide for the passing of the traffic, while the stepped transition panels make it possible to build sections ensuring gradual transition in harmony with the speed range of the railway line. This system solves the complete drainage of rainwater occurring a maintenance free long service life as a result.



VALUE AND QUALITY AWARD TENDER 2024





## Délalföldi Kertészek Zöldség-Gyümölcs Termelői és Értékesítő Mezőgazdasági Szövetkezete

Headquarters: 6600 Szentes, Szarvasi út 3/b.

Mailing address: 6600 Szentes, Szarvasi út 3/b.

Phone: +3663311411

e-mail: [nfo@delkerteszh.hu](mailto:nfo@delkerteszh.hu)

web: [www.delkerteszh.hu](http://www.delkerteszh.hu)

Application:

### **Pritamin Pepper**

One of the lesser-known types of peppers produced in Szentes enriching the Hungaricum Collection is the edible pritamin paprika. The cultivation of pritamin paprika, also known as tomato paprika, has a centuries-old tradition in the region of Szentes. The objective of DélKerTÉSZ is to reintroduce and familiarise consumers with this type of product, which is also popular with Bulgarian gardeners, and to add it to the range of products as an old-new product. The fruit has a thick fleshy, deep red berry with a flattened spherical shape, a very sweet, juicy taste and a very high vitamin C content. Albert Szent-Györgyi is known to have extracted this essential vitamin from tomato peppers.



VALUE AND QUALITY AWARD TENDER 2024





Applicant:

## Dtec Developments Kft.

Headquarters: 1134 Budapest, Kassák Lajos utca 67/A.

Mailing address: 1134 Budapest, Kassák Lajos utca 67/A.

Phone: +36204974225

e-mail: hello@dtec.hu

web: www.dtec.hu

Application:

## TaxiDriver app and software

Unique geospatial and ERP system and mobile app development

The TaxiDriver application and software is a unique geographic information and business management system, the largest taxi interface in Central Europe and a major Hungarian innovation. Thanks to this gap-filling development, thousands of taxis in several countries have now been centralised using the software and app. As sustainable urban mobility, economic growth and reduced pollution are closely linked, the demand for smart and flexible mobility services is growing worldwide, and TaxiDriver fills a significant niche market. DTEC Development Ltd. is the market leader in the Czech Republic and Slovakia with its TaxiDriver business management software, and is also present in Denmark.

The group is working on further development, strengthening its foreign markets and attracting the right financing, with plans to launch TaxiDriver in Asian markets.

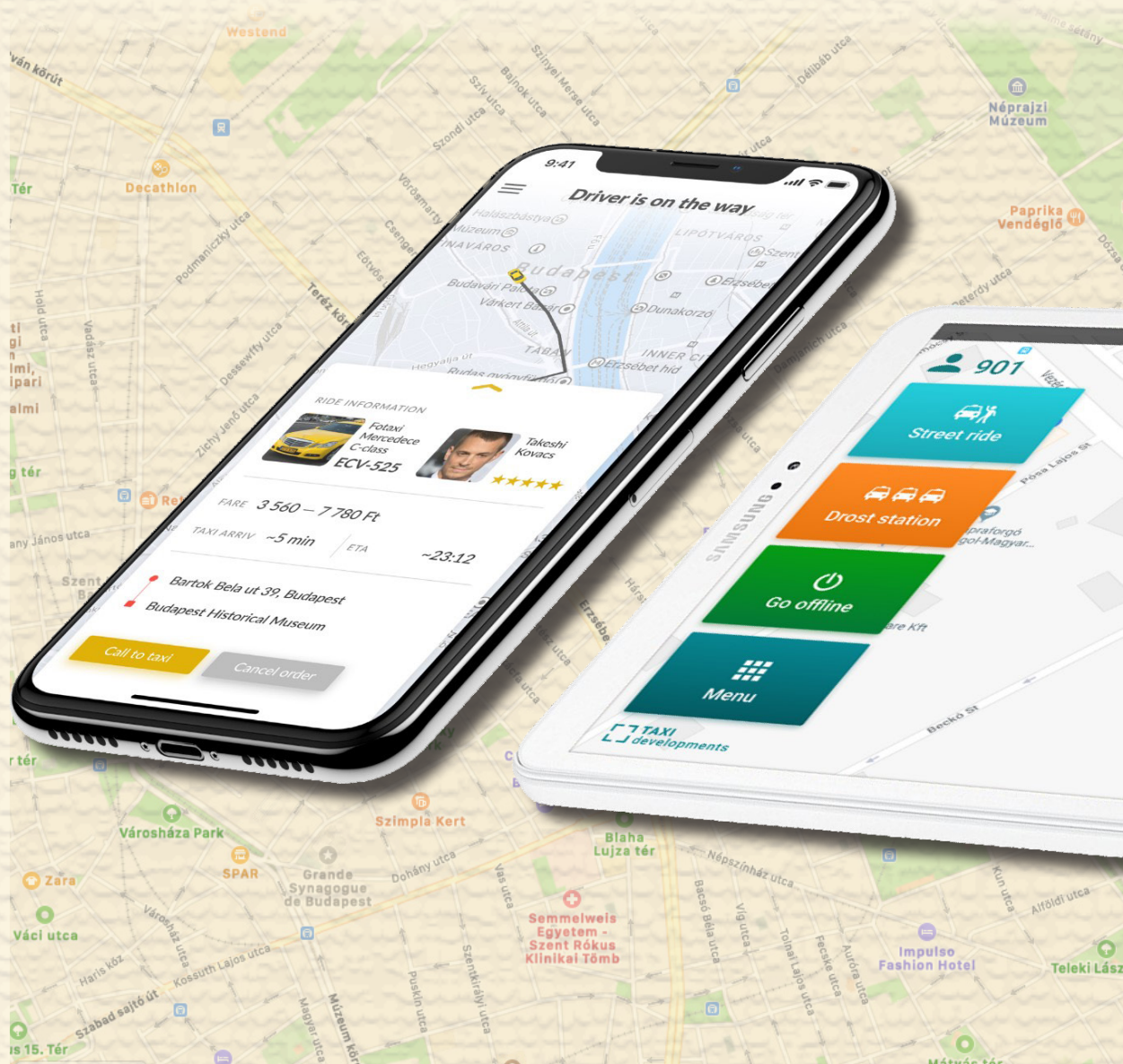

VALUE AND QUALITY AWARD TENDER 2024





Applicant:

## Egy lépéssel több Hajós István Alapítvány

(One step more István Hajós Foundation)

Headquarters: 1036 Budapest, Bécsi út 81.

Mailing address: 1036 Budapest, Bécsi út 81.

Phone: +36707892340

e-mail: [info@egylepesseltobb.hu](mailto:info@egylepesseltobb.hu)

web: [www.egylepesseltobb.hu](http://www.egylepesseltobb.hu)

Application:

### Adopt a family! programme

The One Step More Foundation is committed to social responsibility. Founder István Hajós and his group of companies actively support the community. Their most important programme is „Adopt a Family”, which provides support to families caring for sick children for one year, with a monthly grant of HUF 50,000 per family. The programme is open to anyone who commits a minimum of HUF 5000 per month. Donations are paid directly to service providers, based on cheques sent in by families. This ensures that the aid really goes to the right place. The goal: together, one step more for a better world.

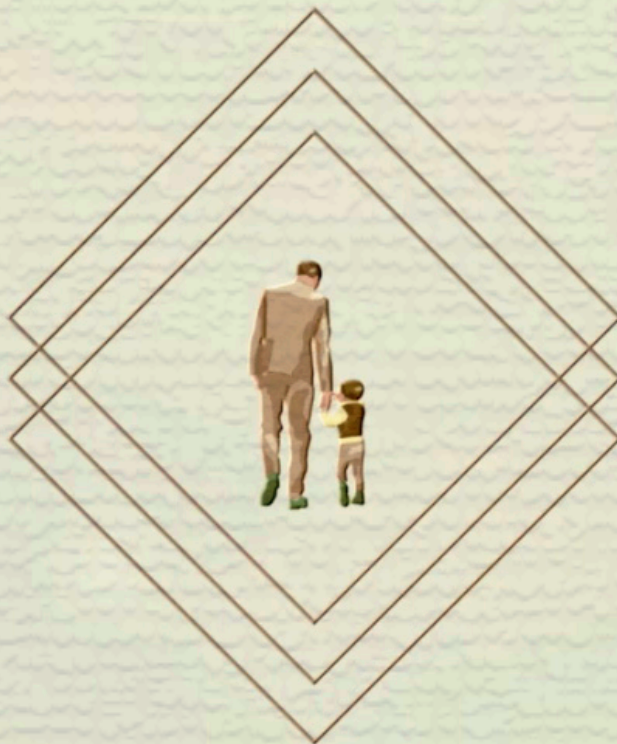

EGY LÉPÉSSSEL TÖBB  
HAJÓS ISTVÁN  
ALAPÍTVÁNY

VALUE AND QUALITY AWARD TENDER 2024





Applicant:

**Gész Gaál és Sziklás Kft.**

Headquarters: 4033 Debrecen, Veres Péter utca 19.

Mailing address: 4033 Debrecen, Veres Péter utca 19.

Phone: +3652520520

e-mail: info@gesz.com

web: www.flavonmax.com

Application:

**Flavon Moon**

In today's overworked, digitalised world, it's increasingly difficult to start the day rested, energised, physically and psychologically recharged. The fruits in Flavon Moon, rich in melatonin, vitamin B6 and antioxidants, are the basis of the herbs and minerals that have been used for decades to help with sleep problems.

Ingredients of the product: sour cherry, cherry, banana, kiwi, date, lemongrass, passionflower and bitter orange biocitrus flavonoid extract.



VALUE AND QUALITY AWARD TENDER 2024





Applicant:

## Good Biom Dental Kft.

Headquarters: 1021 Budapest, Hűvösvölgyi út 30.

Mailing address: 2094 Nagykovácsi, Kazal utca 4/b.

Phone: +36303115116

e-mail: goodbiomdental@gmail.com

web: www.matos.hu

Application:

## Proboil Dietary Supplement

Proboil is a food supplement containing vitamins A and E, peppermint oil, lactobacillus rhamnosus and reuterium. It is a multifunctional product as it acts in the oral cavity, pharynx and intestine. It works both as a simple mouth rinse and as an internal dietary supplement. Its vitamin A content promotes epithelial regeneration, vitamin E is an antioxidant, immune booster, Lactobacilli represents the good bacterial flora and adheres easily to the tooth and mucosal surface in an oily solution.



VALUE AND QUALITY AWARD TENDER 2024





Applicant:

## Gödöllői Tangazdaság Zrt.

Headquarters: 2173 Kartal, Bartók Béla utca 2-10.

Mailing address: 2173 Kartal, Bartók Béla utca 2-10.

Phone: +36202692728

e-mail: koreny.gabor@gtrt.hu

web: www.gombosipalinka.hu

Application:

## Pálinka from Gombos

plum, apple, cherry, Apricots, Cherries, Wild cherries, William Pear, Yellow muscotel pomace, sour cherry and ripe plum brandy

The Hungarian-owned Gombosi Pálinka Distillery, which has been operating for 15 years on the outskirts of Hatvan - Nagygombos, is a company of the Gödöllő Tangazdaság Zrt. They produce premium quality pálinka from plum, apricot, sour cherry and cherry fruits on 300 hectares of their own land. The fruit they buy is also sourced exclusively from local producers. After picking the perfectly ripe, selected fruit, the ageing and distillation processes are followed by traditional methods, reviving centuries-old traditions such as those of the Franciscan priests. The stoned fruit, which is fermented using a special cooling technology, is processed in copper „small stills” by intermittent distillation. The brandies are made only with a middle spirit that faithfully reproduces the flavour and aroma of the ripe fruit. Careful distillation, using the most modern techniques and technological processes known today, under the supervision of highly skilled master distillers, produces a quality raw material that is made into an inimitable work of art by special barrel ageing.



VALUE AND QUALITY AWARD TENDER 2024





Applicant:

**Green Tyre Zrt.**

Headquarters: 8700 Marcali, Kossuth Lajos utca 82.

Mailing address: 8700 Marcali, Kossuth Lajos utca 82.

Phone: +3685310345

e-mail: [info@greentyre.hu](mailto:info@greentyre.hu)

web: [www.greentyre.hu](http://www.greentyre.hu)

Application:

## Safety Rubber Tiles - FS product family

FS-30, FS-40, FS-45, FS-50, FS-55, FS-60, FS-65, FS-70, FS-80, FS-90, FS-100

The raw material for rubber tiles and other products - rubber granulate - is made from used tires, thereby reducing the amount of waste, the burden on the environment and contributing to saving raw materials.

The advantage of shock-absorbing cover lies in their high force-absorbing ability and their resistance to wear with these properties they ensure carefree and safe play for our children

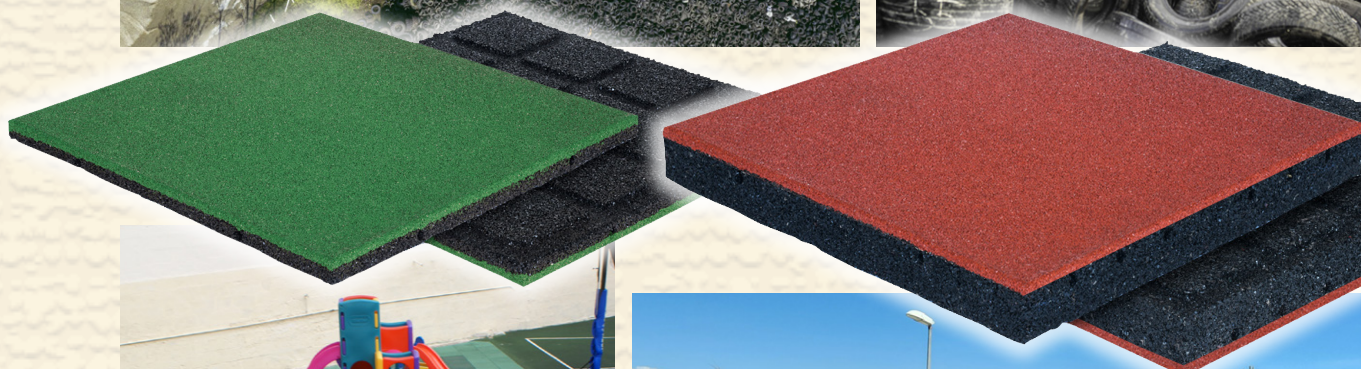

VALUE AND QUALITY AWARD TENDER 2024





VALUE AND QUALITY AWARD TENDER 2024

Applicant:

**GYULAHÚS Kft.**

Headquarters: 5700 Gyula, Munkácsy Mihály utca 7-9.

Mailing address: 5700 Gyula, Béke sugárút 50.

Phone: +3666620220

e-mail: info@gyulahus.hu

web: www.gyulahus.hu

Application:

## Gyulai-Properoni sliced Additive-free Hell Sausage

Meeting the challenge of the 21st century Gyulahús went back to its historical roots. Its harmony of taste reflects the taste of the Gyulai products. They are producing it as their ancestors did. Its recipe does not contain added additives, gluten, lactose, flavour enhancer and preservative (sodium nitrite), so our additive-free Pokol sausage can also be included in the diet of people suffering from food intolerance, which can be now called a popular disease. The product enriches a whole range of different dishes and turns them into a special taste experience from pizzas and pasta to risotto and salads. Its scope of use is limited only by the imagination of the producer.







Applicant:

## Harkányi Gyógyfürdő Zrt.

Headquarters: 7815 Harkány, Kossuth Lajos utca 7.

Mailing address: 7815 Harkány, Kossuth Lajos utca 7.

Phone: +3672580830

e-mail: [info@harkanyfurdo.hu](mailto:info@harkanyfurdo.hu)

web: [www.harkanyfurdo.hu](http://www.harkanyfurdo.hu)

Application:

## Services of Harkány Thermal Spa

In the southern Transdanubian region largest spa, the five star certified Harkányi Spa, an international acknowledged medicinal thermal water awaits quests from summer till winter. Everyone can find the most ideal bathing experience for themselves thanks to for the 7,500 m<sup>2</sup> water surface, which is located on a 13.5 hectares of bathing area. In apposition of the beach and spa pools, wellness and spa services are procurable all year round for those who want to relax, and medical treatments based on the beneficial effect of the thermal water those who are coming for rehabilitation. The continuous improvements of the past period have provided further opportunities to raise the number of guests, and thus the tourist attraction of not only the city, but also the the region has been strengthened.

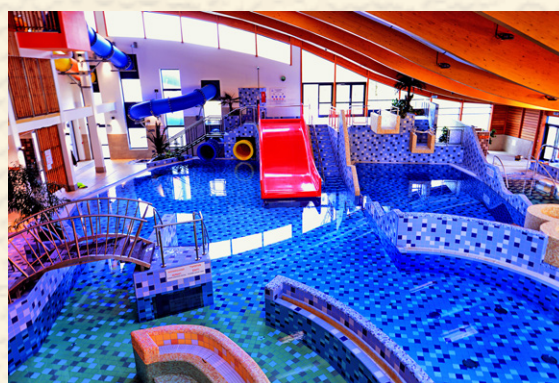

VALUE AND QUALITY AWARD TENDER 2024





Applicant:

## Jó Hentes Élelmiszerértékesítő Kft.

Headquarters: 2336 Dunavarsány, Bethlen Gábor utca 18.

Mailing address: 2336 Dunavarsány, Bethlen Gábor utca 18.

Phone: +36706799389

e-mail: foldi.maria@johentes.hu

Application:

## Good Butcher Gourmet Peasant Sausage range of Kalocsa

Delicious 250g, Spicy 250g, Delicious lédig, Spicy lédig

The uniqueness of Kalocsa sausages is due to the special Kalocsa spice paprika, the spicing and the added beef and the unique smoking process. The peasant sausage of Kalocsa is a traditional dry-aged sausage. The Good Butcher Ltd. respectfully follows the rich world of Hungarian rural lifestyle and traditions.

When creating the Peasant Sausage product line of Kalocsa, the motto was to preserve and pass on these values to future generations. It is not a secret and not so distant goal - apart from expanding the range of Hungarian culinary values - to further popularise this product line not only in Hungary, but also in the world.



VALUE AND QUALITY AWARD TENDER 2024





Applicant:

**KOCH's Torma Kft.**

Headquarters: 6100 Kiskunfélegyháza, I. kerület 241.

Mailing address: 6100 Kiskunfélegyháza, I. kerület 241.

Phone: +3676559401

e-mail: sales@kochs.hu

web: www.kochs.hu

Application:

## **KOCH's Traditional Horseradish, KOCH's Horseradish with Cream**

The consumption of horseradish has a centuries-old tradition thanks to its role in medicine, and later it was also used as a condiment because of its exciting flavour. The goal of KOCH's Horseradish Ltd. is to further strengthen the culture of horseradish consumption, not only among the elderly, but also among the young, as this wonderful plant is not only a spice, but also a medicinal plant, with many positive physiological effects on health. The products manufactured at KOCH's Torma Ltd. are produced using advanced technology to the highest international quality standards.



VALUE AND QUALITY AWARD TENDER 2024





VALUE AND QUALITY AWARD TENDER 2024

Applicant:

**Kunság-Szesz Zrt.**

Headquarters: 6200 Kiskőrös, Bánffy utca 35-37.

Mailing address: 6200 Kiskőrös, Bánffy utca 35-37.

Phone: +3678414140

e-mail: info@kunsagszesz.hu

web: www.kunsagszesz.hu

Application:

**Pilvax Coffee Liqueur**

In 2021, at the request of the Kiskőrös Petőfi Association and the Petőfi 200 Memorial Committee, Kunság-Szesz Zrt. recreated the noble and famous drink, Pilvax Coffee Liqueur, based on the original recipe, as the drink of the commemorative year. The Kunság-Szesz Zrt. as a local patriotic, traditional, family-owned company based in Kiskőrös, is pleased to support the work of the Petőfi 200 Memorial Committee. I would like to introduce the Pilvax Coffee Liqueur to a wider audience - connecting the past with the present and creating an opportunity to preserve and cherish memories and traditions - and to become part of the Petőfi legend and traditions, while providing a pleasant taste experience and even promoting the cultured consumption of beverages.



A Pilvax-kávéház külsége 1848-ban.



A Pilvax-kávéház belseje 1848-ban.



*Tied vagyok, tied, hazám!  
E szív, e lélek;  
Kit szeretnék, ha tégedet  
Nem szeretnék?*

*Pilvax*

60 L alk. 33% V





Applicant:

**Lidl Magyarország Kereskedelmi Bt.**

Headquarters: 1037 Budapest, Rádl árok 6.

Mailing address: 1037 Budapest, Rádl árok 6.

Phone: +3613466000

e-mail: [info@lidl.hu](mailto:info@lidl.hu)

web: [www.lidl.hu](http://www.lidl.hu)

Application:

## **Bacon bread pancake 150g**

The bacon bread pancake is among the most popular dishes, but it is time-consuming to prepare. At Lidl, the pre-made, delicious and spicy Bacon Bread Pancake makes it possible to bring this popular dish to everyone's table at an affordable price and with simple use. It is made with modern technology, using excellent ingredients, based on a traditional recipe, with a delicious, spicy flavour, which is immediately frozen, shock frozen and the product is delivered in this form to Lidl Hungary stores, where it is freshly baked and placed on the counters of Lidl's fresh bakery.



VALUE AND QUALITY AWARD TENDER 2024





Applicant:

**Lidl Magyarország Kereskedelmi Bt.**

Headquarters: 1037 Budapest, Rádl árok 6.

Mailing address: 1037 Budapest, Rádl árok 6.

Phone: +3613466000

e-mail: [info@lidl.hu](mailto:info@lidl.hu)

web: [www.lidl.hu](http://www.lidl.hu)

Application:

**Sausage Pizza 150g**

In today's fast-paced world, it's important to find tasty, quick-to-eat food with as little energy and time as possible. The sausage pizza is very popular with customers, and the thick sausage with paprika used is a Hungarian flavour. It is made with modern technology, excellent ingredients, based on a classic recipe, which due to the immediate sudden freezing retains all the properties of fresh food. It is delivered in this form and baked fresh in Lidl Hungary stores.



VALUE AND QUALITY AWARD TENDER 2024





Applicant:

**Lidl Magyarország Kereskedelmi Bt.**

Headquarters: 1037 Budapest, Rádl árok 6.

Mailing address: 1037 Budapest, Rádl árok 6.

Phone: +3613466000

e-mail: info@lidl.hu

web: www.lidl.hu

Application:

### **Pilos Cream cheese dessert with vanilla, 90g**

The nutritional composition of Pilos vanilla flavoured post-cooled cream cheese dessert is exceptionally high in protein and high in milk concentrate compared to other spoonable chilled milk desserts. Pilos vanilla cream cheese dessert is made in Hungary from continuously controlled high quality ingredients, using the latest production technology in recyclable packaging. Lidl Hungary's activities are characterised by outstanding environmental awareness, a good example of which is the production and distribution of the Pilos vanilla cream cheese dessert, which further supports sustainability and thus contributes to the achievement of the set goals.



VALUE AND QUALITY AWARD TENDER 2024





Applicant:

**Lidl Magyarország Kereskedelmi Bt.**

Headquarters: 1037 Budapest, Rádl árok 6.

Mailing address: 1037 Budapest, Rádl árok 6.

Phone: +3613466000

e-mail: [info@lidl.hu](mailto:info@lidl.hu)

web: [www.lidl.hu](http://www.lidl.hu)

Application:

## **Pilos grated mozzarella cheese lactose free 200g**

Due to the increasing number of people suffering from certain food intolerances, Lidl Hungary decided several years ago to expand the range of lactose-free products available. The different appearance of these products, and the expansion of the range, is a priority. In addition to their usefulness, they also have the advantage of being suitable for all consumers, because they can satisfy their need for variety. Pilos lactose-free grated mozzarella is an excellent choice for consumers with special dietary needs. With its characteristic lactose-free flavour and economical form, it is one of the most popular cheeses. The product comes in resealable packaging, which is extremely useful and practical because it preserves the original quality for longer. Production is carried out in state-of-the-art conditions, under strict control and to the highest quality standards.

VALUE AND QUALITY AWARD TENDER 2024







Applicant:

**Lidl Magyarország Kereskedelmi Bt.**

Headquarters: 1037 Budapest, Rádl árok 6.

Mailing address: 1037 Budapest, Rádl árok 6.

Phone: +3613466000

e-mail: info@lidl.hu

web: www.lidl.hu

Application:

## Turkey ham product family

Pikok, Toast Ham Turkey sliced 100g, Pikok thigh ham sliced 100g, Pikok Turkey breast ham sliced 100g, Pikok Pure turkey breast ham sliced additive free 100g

Part of the reason for the creation of the Pikok Turkey Ham range is the fact that the consumption of turkey meat in Hungary is at the forefront of the world due to its many positive physiological effects and the fact that the Pikok Pure own brand has long enjoyed unbroken popularity. The products are of the highest quality and meat content on the domestic market, made exclusively from natural ingredients, free from colourings, preservatives and flavour enhancers. Low in fat, they are a very important source of complete protein, which also contains many minerals. The range has been designed to meet consumer needs to the fullest, with rigorously controlled and modern manufacturing. The range is very popular with customers encouraging further developments as well.



VALUE AND QUALITY AWARD TENDER 2024





Applicant:

## Lidl Magyarország Kereskedelmi Bt.

Headquarters: 1037 Budapest, Rádl árok 6.

Mailing address: 1037 Budapest, Rádl árok 6.

Phone: +3613466000

e-mail: info@lidl.hu

web: www.lidl.hu

Application:

### Solevita Peach-Orange nectar 51%, 1l

Fruit nectars are popular for their pleasant drinkability and flavour composition. Peach and orange nectar from the Solevita range quickly became a consumer favourite following its launch in late 2023. The main goal of the product concept was to create a product with innovative and unique characteristics, which is unique on the Hungarian market, the product contains orange concentrate as well as apricot and peach concentrate. It is also important that the product is preservative-free and rich in nutrients and fibre. Another important aspect of the 51% fruit content was to ensure that all fruits were represented in sufficient proportion (orange juice concentrate: 30%, peach puree concentrate: 13%, apricot puree concentrate: 8%). The result is that the nectar tastes sweet (as a result of the peach), but also has a noticeable orange acidity. It contains no preservatives or colouring agents. The nectar is currently available in Lidl Hungary stores for HUF 599, which makes it a great value for money choice.

VALUE AND QUALITY AWARD TENDER 2024







Applicant:

## Losonczy Innovation Kft.

Headquarters: 5600 Békéscsaba, Almáskerti Ipari park 8/2.

Mailing address: 5600 Békéscsaba, Almáskerti Ipari park 8/2.

Phone: +3666519930

e-mail: losonczy@losonczy.hu

web: www.losonczy.hu

Application:

## PRO measuring machine family

AXIS PRO, TOWER PRO, HOUSING PRO

Losonczy Innovation Ltd. tries to cover the entire production process with its products according to the needs of its customers. They design and manufacture the equipment needed to grip the workpiece, the interchangeable cutting tool and tool clamp for machining, and the special measuring instrument to check the operation. Meeting the challenges of Industry 4.0, PRO measuring devices can be used in any automated, robotic (or human-served) production cell for in-process inspection of parts, individual identification of workpieces, analysis of measured values, evaluation of results, machine tool correction and data storage.



Meas	Meas	Calculated	Start end	meas	diff	OK
0,0152	0,0000			40,0099	-0,0001	
0,0088	0,0000			40,0109	0,0009	
0,0012	0,0000			0,0015	0,0015	
-0,0019	0,0000			44,8764	-0,0436	
0,0042	0,0000			0,0009	0,0009	
-0,0004	0,0000			37,9632	0,0007	
				37,9617	-0,0008	
				0,0007	0,0007	
				0,0150	0,0150	
				0,0202	0,0202	
				0,0003	0,0003	
				0,0002	0,0002	
				0,0001	0,0001	



VALUE AND QUALITY AWARD TENDER 2024





Applicant:

**McIntosh Richard Duncanné**

Headquarters: 4241 Bocskaiert, Baross Gábor utca 9.

Mailing address: 4241 Bocskaiert, Baross Gábor utca 9.

Phone: +36308115264

e-mail: piroskamcintosh@gmail.com

Application:

## **Crochet pictures exhibition**

Piroska McIntosh usually offers her crocheted pictures for exhibitions to the Congregations of the Reformed Churches and they are happy to display them in their meeting rooms, churches, schools, retirement homes and community centres. The pictures are not for sale. In our over-worked, hectic world, this display and exhibition of beauty is extremely important and exemplary. Making products like these gives meaning to life. It is also good for the health of the body and soul, it relieves stress. It stimulates creativity and develops a sense of beauty. It guards tradition, cultivates cultural life.



VALUE AND QUALITY AWARD TENDER 2024





Applicant:

**Natur Gold Global Kft.**

Headquarters: 3752 Szendrő, Nagyállomás út 14.

Mailing address: 3752 Szendrő, Nagyállomás út 14.

Phone: +3648560525

e-mail: [info@naturgoldglobal.com](mailto:info@naturgoldglobal.com)

web: [www.granaanticoshop.hu](http://www.granaanticoshop.hu)

Application:

**Grana Antico products family**

Einkorn baking mix, wholemeal 450g, organic; Einkorn baking mix, white 400g, organic

Spelt baking mix, wholemeal 450g, organic; Spelt baking mix, white 400g, organic

It is now clear that the natural and sustainable path must be followed. The environment should not be exploited, and we should live and produce by taking care of the purity of food as well. The search for these values has led Nature Gold Global Ltd. for decades to the path of dealing with organic ancient grains. The Grana Antico range is composed of organic ancient grains (Spelt, Einkorn) that share the common characteristic of facilitating the incorporation of a balanced diet into everyday life. The ancient crops have not been genetically modified and have not been treated with chemicals or fertilisers. Baking mixtures containing Einkorn Ferment are also suitable for fermentation.



VALUE AND QUALITY AWARD TENDER 2024





Applicant:

## Nádudvari Élelmiszer Feldolgozó és Kereskedelmi Kft.

Headquarters: 4181 Nádudvar, Gutenberg utca 1.

Mailing address: 4181 Nádudvar, Pf.: 23.

Phone: +3654480633

email: nadudvari@nadudvari.hu

web: www.nadudvari.hu

Application:

### Nádudvari Chef Exclusive Meatballs product family

Nádudvari Chef Exclusive Meatballs stuffed with cheese

Nádudvari Chef Exclusive Meatballs stuffed with jalapeno and cheese

Nádudvari Chef Exclusive Meatballs stuffed with broccoli

Nádudvari has been committed to the production of high-quality food for many years. During product development, it is important to them that well-proven raw materials and modern production technology result in forward-looking products. During the development of Chef Exclusive stuffed meatballs, their specialists chose the well-proven creamy cheese as one of the ingredients, which already works successfully in several of their products. The cheese-filled meatball enchants us with its soft flavours, the cheese-jalapeno meatball with its full flavours is also very popular with those who like spicy and hot flavours. The broccoli-filled meatballs are uniquely light. These products, like most of their frozen products, can be easily prepared in the oven without oil.



VALUE AND QUALITY AWARD TENDER 2024





Applicant:

## Nádudvari Élelmiszer Feldolgozó és Kereskedelmi Kft.

Headquarters: 4181 Nádudvar, Gutenberg utca 1.

Mailing address: 4181 Nádudvar, Pf.: 23.

Phone: +3654480633

email: nadudvari@nadudvari.hu

web: www.nadudvari.hu

Application:

### Nádudvari Fruit Yoghurts 125g with added vitamins C and D peach, strawberry, red fruits

Nádudvari Ltd. has been committed to producing high quality food for many years. A few years ago, the yogurt portfolio was supplemented with the first highly successful layered cream yogurt family. Encouraged by the successes, in 2023 Nádudvari Ltd. expanded its offer to also target health-conscious customers. The new fruit yogurts support the immune system and the maintenance of healthy bones with added vitamins C and D. The first two members of the family hit store shelves in the popular strawberry and peach flavours. In 2024, the series was already expanded with a red fruit yogurt and a limited summer flavour. Nádudvar's environmentally conscious operation is demonstrated by the fact that the new yogurts are delivered to consumers in paper-rimmed cups, thus reducing the plastic load on the environment.



VALUE AND QUALITY AWARD TENDER 2024





Applicant:

**Planet Herbal Kft.**

Headquarters: 9024 Győr, Vasvári Pál utca 1. B épület

Mailing address: 9024 Győr, Vasvári Pál utca 1. B épület

Phone: +36703923773

e-mail: nagyker@pranagarden.com

web: www.pranagarden.com

Application:

## **Pranagarden Prog-Estro Balance Cream**

Prog-Estro Balance Cream is a naturally based, vegan formula that supports optimal progesterone levels in the female body and the maintenance of a healthy progesterone-estrogen balance, without hormones, using three different active ingredients in synergistic action. A convenient, natural, herb-supported, drug-free solution that can contribute to optimal progesterone levels in the body. External application in the form of body butter is very simple, and in many cases more effective than internal absorption in terms of absorption of active ingredients. With natural ingredients - maca, wild yam extract and amaranth - it ensures that hormonal imbalances do not cause problems in everyday life



VALUE AND QUALITY AWARD TENDER 2024





Applicant:

## Poultry Brasov Kft. (Ro)

Headquarters: Románia RO-505100 Feketehalom, Külterület,

Feketehalom- Nagyszeben országút 2km, Brassó megye

Mailing address: Románia RO-505100 Feketehalom, Külterület,

Feketehalom-Nagyszeben országút 2km, Brassó megye

Phone: +40736999189

e-mail: bv.office@pinvest.ro

web: www.szekelycsurke.ro

Application:

### “Székely Csürke” fresh and frozen chicken meat

**fresh products:** vacuum packed: breast fillets, whole thighs, drumsticks, upper thighs, wings; protective packaging: breast fillets, whole thighs, drumsticks, upper thighs; bagged packaging: whole chicken; **frozen products:** vacuum packs: breast fillets, whole thighs, drumsticks, upper thighs, wings; bagged packs: breast fillets, whole thighs, drumsticks, upper thighs, whole chicken

Poultry Brasov created its own brand, Székely Csürke, in 2022 to signal to consumers that they are in luck with a locally produced, high-quality range of products from Transylvania. Székely Csürke chicken meat stands out among the products available on the Hungarian and Romanian markets, as the production process can be fully traced from the first grain to the consumer's table.



VALUE AND QUALITY AWARD TENDER 2024





Applicant:

**Rachel Care Kft.**

Headquarters: 4400 Nyíregyháza, Sarkantyú utca 33/A. 3/7.

Mailing address: 4400 Nyíregyháza, Sarkantyú utca 33/A. 3/7.

Phone: +36708022937

e-mail: [info@rachelcare.hu](mailto:info@rachelcare.hu)

web: [www.rachelcare.shop](http://www.rachelcare.shop)

Application:

## **Rachel Care Anti-aging Day Cream**

Rachel Care Anti-Aging Day Cream combines the most modern cosmetic ingredients with the natural power of herbs. These active ingredients have amazing skin-tightening and moisturizing effects by themselves, but at the same time - combining with appropriate expertise - thanks to the synergy of the natural ingredients, we get a multiple beneficial effect.



VALUE AND QUALITY AWARD TENDER 2024





Applicant:

**Roll-Lamell Kft.**

Headquarters: 2120 Dunakeszi, Bem utca 5.

Mailing address: 2120 Dunakeszi, Bem utca 5.

Phone: +3627544544

e-mail: [info@roll-lamell.hu](mailto:info@roll-lamell.hu)

web: [www.umbroll.hu](http://www.umbroll.hu)

Application:

**Umbroll External Venetian Blinds**

**C80, Z90, S90, F-80|100, Self-supported, Multiped**

The Umbroll® Venetian blind is a modern and efficient shading system with a wide range of useful features and aesthetic variety. By definition the Venetian Blinds are outdoor version of re-luxes, but bigger and stronger. As a premium outdoor shading system, they are also particularly important in terms of energy efficiency and environmental friendliness. The sun rays heat up interiors quickly through the large glass surfaces, particularly in the summer months. Our venetian blinds an energy-saving solution to this problem, as their design prevents the glass surfaces from overheating and has been proven to provide a better thermal comfort in the home.

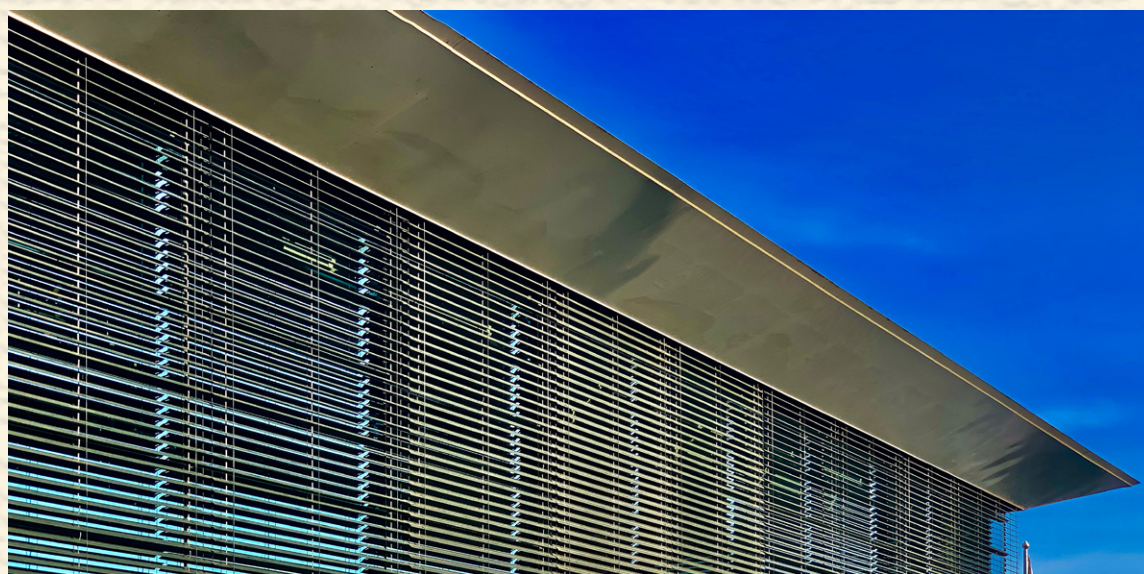

VALUE AND QUALITY AWARD TENDER 2024





Applicant:

## RONIX Szervező és Szolgáltató Kft.

Headquarters: 1153 Budapest, Bocskai utca 116.

Mailing address: 1153 Budapest, Bocskai utca 116.

Phone: +3613224625

e-mail: info@ronix.hu

web: www.ronix.hu

Application:

### **Pest control, Insect and rodent extermination, Bird protection, Bio rodent control, Risk analysis**

RONIX Organizing and Servicing Ltd. has more than 45 years of expertise in the field of sanitary pest control, which is unique in Hungary today.

With decades of professional experience and a large number of qualified employees (sanitary gas operators, sanitary pest control technicians, experts), they can find a solution for any pest control-related task.

Nationwide coverage and well-organised logistics allow them to respond quickly, with delivery even within 4 hours. Always using the latest technologies, the best machinery and the latest exterminators. It strives to use pesticide free technologies in order to reduce pollution and protect the environment.



VALUE AND QUALITY AWARD TENDER 2024





Applicant:

**Scratch & J Kft.**

Headquarters: 1136 Budapest, Tátra utca 5/A. -1. 2.ajtó

Mailing address: 1051 Budapest, Dorottya utca 9.

Phone: +36301030830

e-mail: [info@sjrelaxstudio.hu](mailto:info@sjrelaxstudio.hu)

web: [www.sjrelaxstudio.hu](http://www.sjrelaxstudio.hu)

Application:

**Scratching therapy**

a unique body relaxation service patented in Europe

It is the first and only nail body relaxation service in Europe. During scratching, five million sensory nerve cells, mostly located in the back, signal the brain. The back is the main stress centre of the body, so when you use Scratching Therapy, you get rid of a lot of tension. Scratching is a unique stress-relieving technique that provides maximum relaxation in up to half an hour. The treatment is performed by a professional Scratcher, who draws fine lines on the skin with his nails, giving a wonderfully soothing sensation.

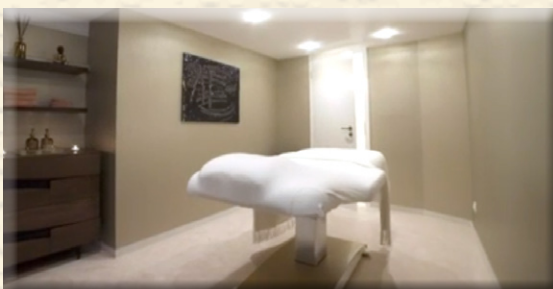

VALUE AND QUALITY AWARD TENDER 2024





VALUE AND QUALITY AWARD TENDER 2024

Applicant:

**SOLE-MiZo Zrt.**

Headquarters: 6728 Szeged, Budapesti út 6.

Mailing address: 6728 Szeged, Budapesti út 6.

Phone: +3662569036

e-mail: [solemizo@solemizo.bonafarm.hu](mailto:solemizo@solemizo.bonafarm.hu)

web: [www.mizo.hu](http://www.mizo.hu)

Application:

## MiZo Coffee Selection lactose free roasted pistachio flavoured latte 330ml

MiZo Coffee Selection brings real indulgence to life. Made with 100% MiZo milk and the expertise of local farmers, these coffees offer the opportunity to enjoy coffee without compromise. It also provides a range of alternatives for consumers with special needs. In addition to classic flavours, our flavoured range is constantly expanding and has now grown to three. It is always our right travel partner thanks to its resealable packaging.







Applicant:

**T-CAD Stúdió Bt.**

Headquarters: 2699 Szügy, Ipari park Hrsz.: 024/152/A

Mailing address: 2699 Szügy, Ipari park Hrsz.: 024/152/A

Phone: +36303141975

e-mail: [cad@tcad.hu](mailto:cad@tcad.hu)

web: [www.tcad.hu](http://www.tcad.hu)

Application:

## Design and manufacture of special purpose machines, special tools; 3D scanning; Project management

A 100% Hungarian-owned (Nógrád) company designing unique target machines and tools has been continuously expanding its activities and adapting to market needs since its foundation. New challenges required the development of a new business line (3D scanning). A highly advanced solution is to combine scanning with engineering design tasks. This has enabled us to provide a full range of services to our clients from project inception to implementation.

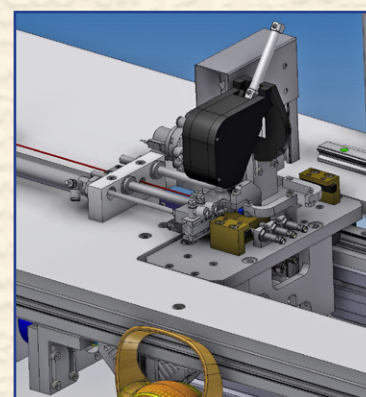
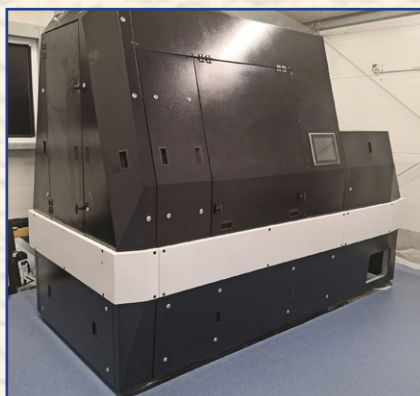
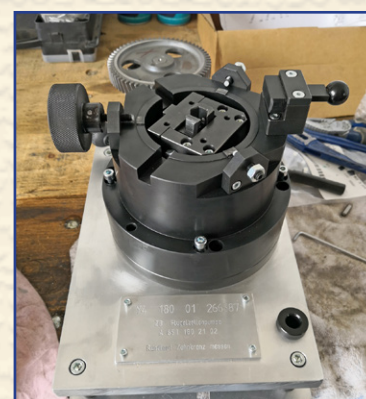

VALUE AND QUALITY AWARD TENDER 2024





# VALUE AND QUALITY AWARD TENDER 2024

Applicant:

## **Terék Művészeti Kft.**

Headquarters: 2192 Hévízgyörk, Kossuth Lajos utca 61.

Mailing address: 2192 Hévízgyörk, Kossuth Lajos utca 61.

Phone: +36703863910

e-mail: [terek.jozsef@gmail.com](mailto:terek.jozsef@gmail.com)

[terekmuveszetikft@gmail.com](mailto:terekmuveszetikft@gmail.com)

web: [www.terekjozsef.hu](http://www.terekjozsef.hu)

[www.terekjozsef.com](http://www.terekjozsef.com)

Application:

## **Performance pieces for tarogató and piano**

"Performance Pieces for Tárogató and Piano" is a unique composition service that has resulted in new classical music for tárogató-piano duo. The reform for the development of the current version of the tárogató began 130 years ago, with the main aim of giving it a worthy place in Hungarian music, in addition to technical and tonal innovation, and to make it known as a Hungarian instrument in Europe as a musical innovation. The present competition continues this work, as there are hardly any classical scores written for the tárogató, and this is the first of 75 works with piano accompaniment, which will help to promote the instrument both in Hungary and internationally, both from an educational and a performing arts point of view. The new compositions will create opportunities for bilateral cultural cooperation serving as a teaching aid in the curricula of the classical tárogató, which does not exist today, and provide a realistic picture of the virtuosic and varied possibilities of the tárogató for audiences and performers.







Applicant:

## Zalakarosi Családi-, Élmény- és Gyógyfürdő Zrt.

Headquarters: 8749 Zalakaros, Termál út 4.

Mailing address: 8749 Zalakaros, Termál út 4.

Phone: +3693340420

e-mail: info@zkf.hu

web: www.zkf.hu

Application:

### Energetic innovation using medicinal water of Zalakaros

To solve the energy crisis and to become independent from fossil energy sources, the Zalakaros Spa Ltd. has built a new geothermal energy network to replace fossil gas energy. By designing the system, it was possible to supply the 85–90-degree upwelling water to the Zalakaros Spa facilities through sized heat exchangers. The energy network can replace 200–250 thousand cubic metres of gas. The energy investment in the spa is a priority for the future in terms of environmental awareness and sustainability. The process of rethinking the properties of available water resources is coupled with a unique solution that can set an example for solving similar situations.



VALUE AND QUALITY AWARD TENDER 2024